

NHS England South West Clinical Senate

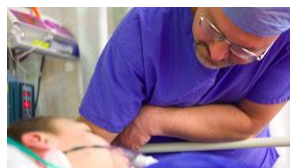

Dr Phil Yates,
Senate Chair
17/03/16

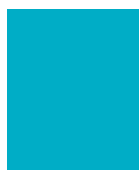

Today's Arrangements

- No fire alarms & facilities;
- Sign up for lunchtime sessions with speaker of your choice;
- Time for networking too.
- Break out sessions this afternoon - Where will you go?
- Phil Hammond 'Turning Healthcare on its Head!'
- Mobiles to silent but tweets via #swdigiday and @southwestsenate.



ON SILENT MODE PLEASE

Clinical Senates Map

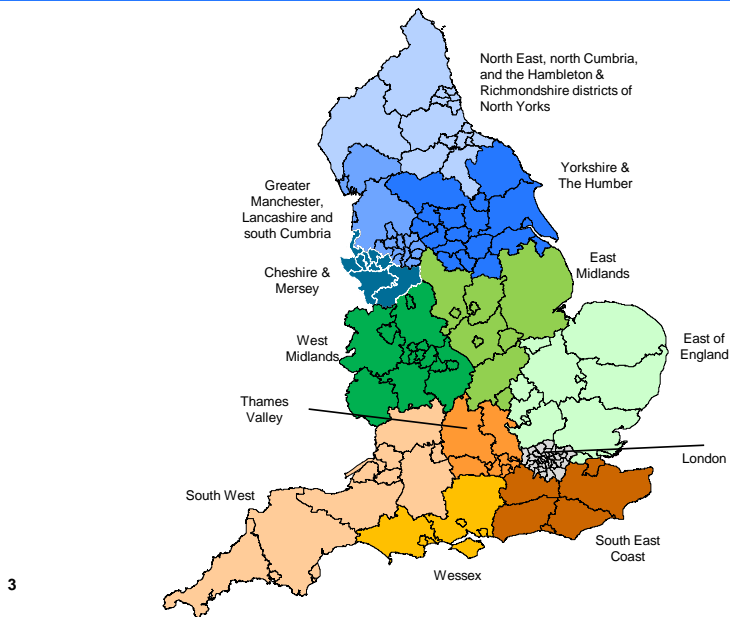

South West Clinical Senate



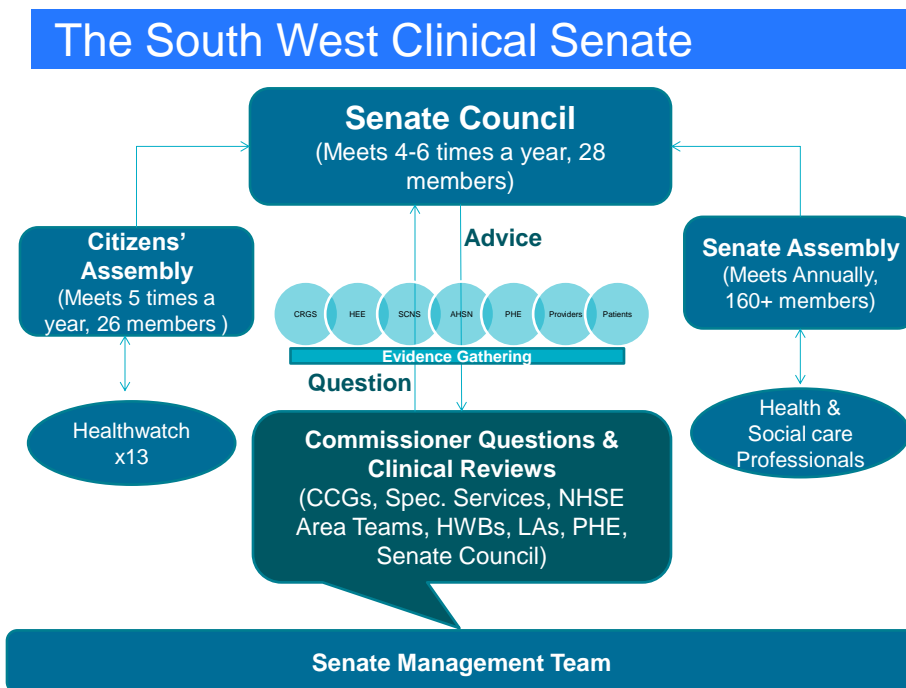

Senate advice to date

- Specialised commissioning principles;
- Model for HIV network;
- Acute to community interface;
- Emergency surgery;
- Community services transfer;
- Public health interventions;
- Critical co-dependencies of acute services;
- Mental health service reconfiguration;
- Surgical decision making at MDT.

Senate clinical reviews

- Emergency surgery ;
- Rehabilitation services;
- Spinal surgery;
- Community services;
- Sustainability & Transformation Plans (STPs); with links to 'Digital Roadmaps';
- Success Regime
- Vascular & outcomes based commissioning
- Also – mental health /public health / UECNs recommendations follow up

The main objectives of the 5 Year Forward View

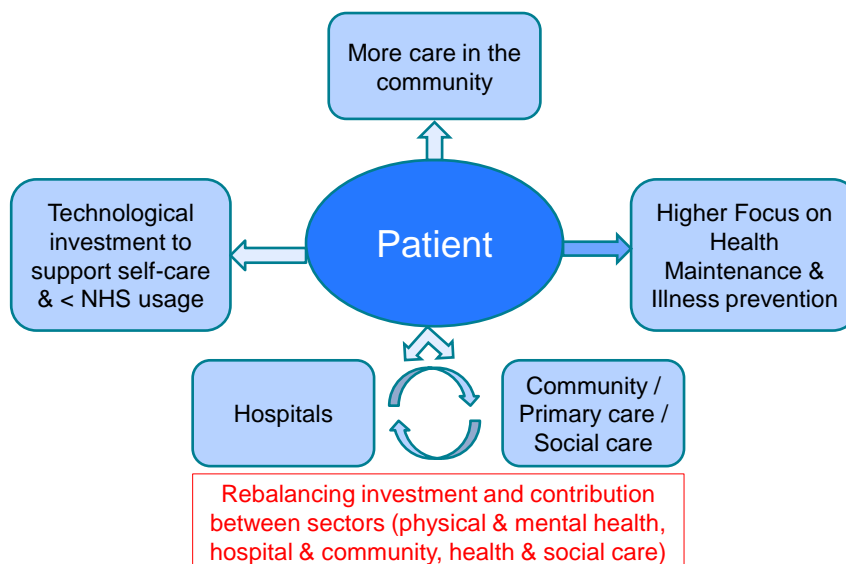

Integrating Care

Present	1 ^o Care	2 ^o & 3 ^o Care
	GP led	Consultant led
	All undifferentiated illness Little cross referral Limited long-term conditions (LTCs)	Most access to diagnostics Acute management major conditions Long-term follow up of many LTCs

Future	Pre-primary	1 ^o & Community delivered		2 ^o & 3 ^o
	SSD / Pharmacist / Nurse	GP	Consultants	
	Web-based advice; self-help tel, email & SMS; expert patient; community & 3 rd sector support	Assessing risk Minor illness & injury Specialist nurses LTCs & social care Telemedicine Telehealth	Diagnostic uncertainty 1 st diagnosis Complex problems Follow ups Sub-specialisation Multiprofessional teams	Major surgery High-tech interventions True 'consultancy' Teaching & support

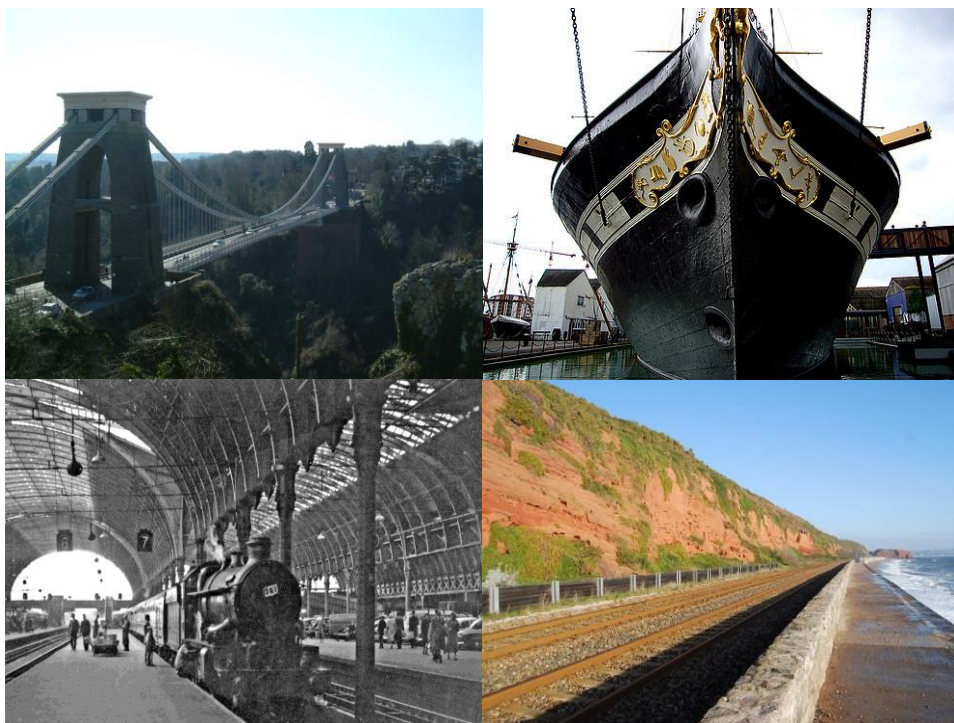

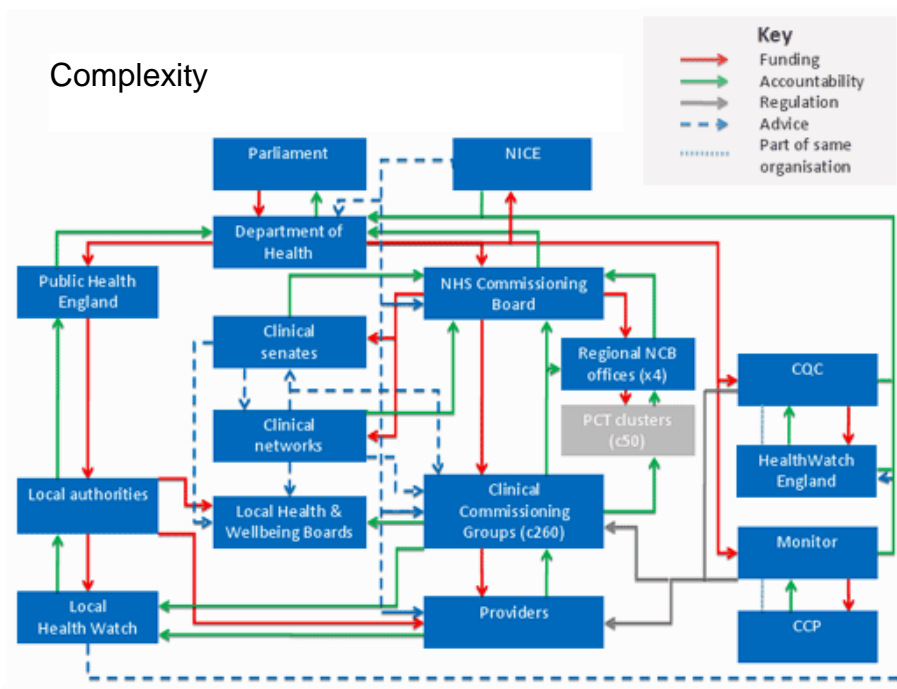
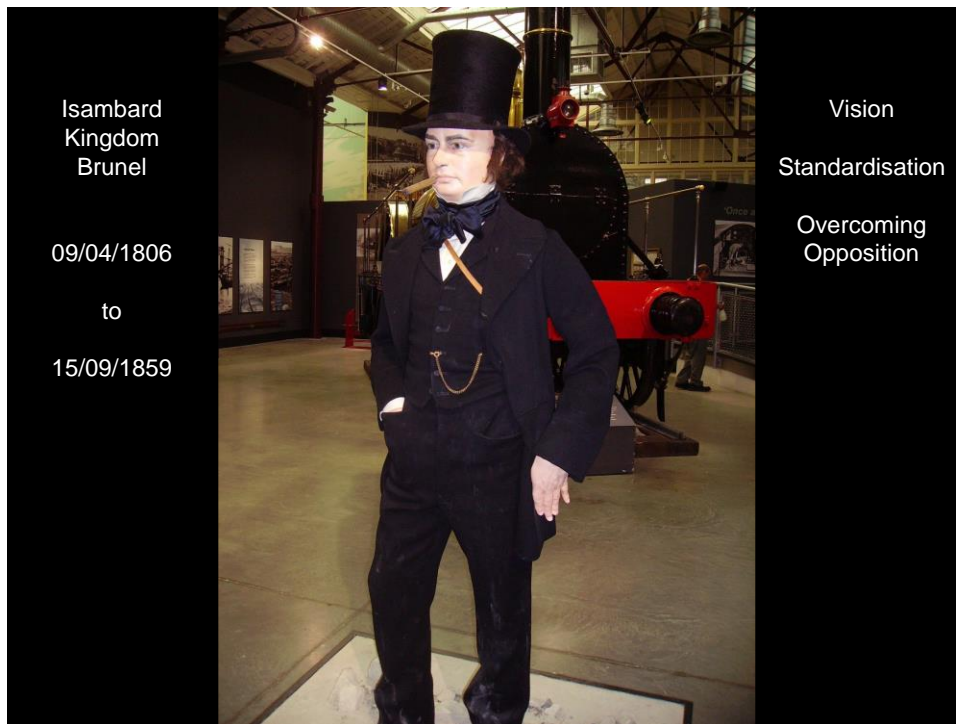

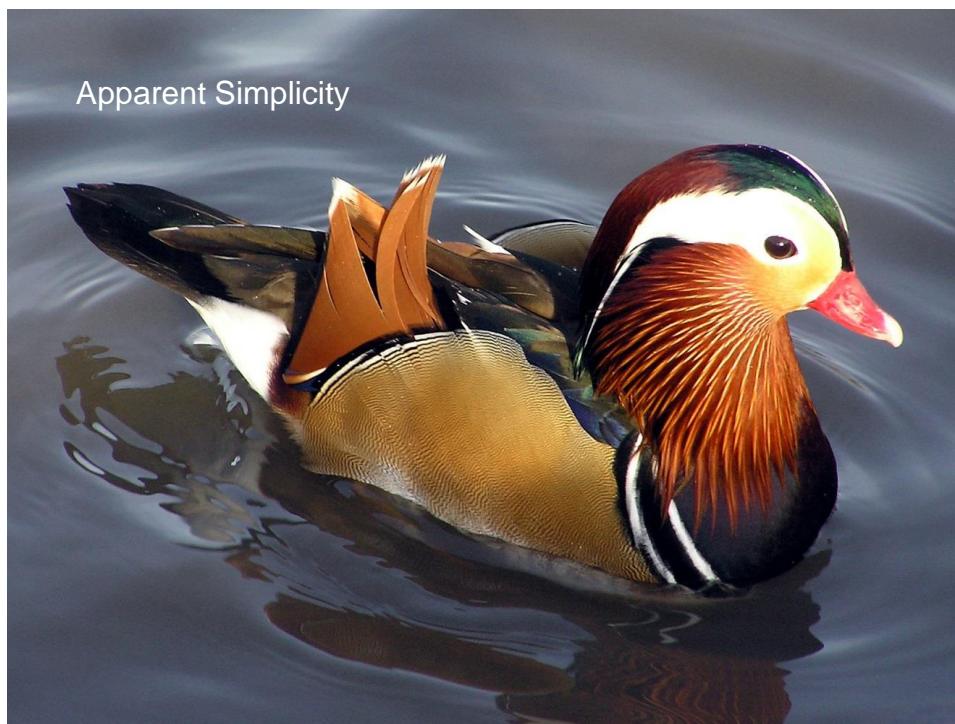

Summary

- The NHS has been much slower to adopt new technologies than other industries.
- Greatest gains are less about add-on bits of clever kit, much more about redesign of processes from end to end.
- The NHS' Plans need to be in line with the 5YFV.
- The perception of services should be simple to the end user.
- Where there's clear vision, determination and structure we can make progress fast.



Finally ... the Senate Management Team

- Senate Manager: Ellie Devine
- Admin Support: Sarah Redka
- Senate Chair: Dr Phil Yates
- Senate Deputy Chair: Prof David Halpin
- Associate Director of SCN and Senate: Sunita Berry
- Med Director BNSSSG Area Team, NHSE: Dr Caroline Gamlin

NB all part-time
for the Senate

Thank you!

Thank all of you too!

So, let's get started ...